



## General Accessories

---

### Hardware

Heavy Duty Door Clamping Hardware .....	378
Quick Release Clamp .....	378
Lifting or Pull Handles .....	378
Pull Ring Catch .....	378
Door Clamping Hardware .....	378
Latch Kits for Single Door Type 12 Enclosures .....	379
Lock Kit for NEMA 1 Enclosures .....	379
Lock Kit for 1418 Type 4 and 12 Enclosures .....	379
Mounting Hardware .....	380-381
UL/CSA Hardware Kits .....	382
Quarter Turn Inserts and Keys .....	382
Replacement Quarter Turn Assemblies .....	382
Eclipse Junior Padlock Adaptor .....	383
Eclipse Junior Wing Knob .....	383

---

### Oil Tight Hole Plugs

Steel Hole Plugs .....	383
Stainless Steel Hole Plugs .....	383

---

### Panels and Panel Accessories

Panels for 1414/PJ/EJ Series Enclosures .....	384
Panels for 1418, 1447, and Series 2000 Wallmount Enclosures .....	384
Panels for Eclipse Series Enclosures .....	385
Panels for 1420 Series Enclosures .....	385
Panels for 1422 Series Enclosures .....	385
Panels for N1A Series Enclosures .....	386
Terminal Kits for 1414/PJ/EJ Series Enclosures .....	386
Terminal Kit for 1418/Series 2000 Enclosures .....	387

---

### Power Bars

Rail Mount, Rear Outlet Power Bar .....	388
Rail Mount, Front Outlet Power Bar .....	388
Heavy Duty Power Bar .....	389
Vertical Power Strip .....	390

---

### General Accessories

Remote Receptacle .....	391
Steel and Stainless Steel Window Kits .....	391
Flange Disconnect Operator Adaptor Kits .....	392
Door Stop Kit .....	393
Drip Shield Kit .....	393
Light Kit & Accessories .....	393
Floor Stand Kit .....	394
Pedestal .....	395
Touch-Up Paint .....	396
Louvered Ventilating Plate .....	396
Casters .....	396
1425 Series Casters .....	396
Enclosure Stabilizers .....	397
Literature Pocket Kit .....	397
Panel Lifting Handles .....	397
Neoprene Gasket Kit - NEMA 12 Enclosures .....	397
Urethane Gasket Kit - NEMA 4, 4X Enclosures .....	397

# General Accessories

## Hardware



### Heavy Duty Door Clamping Hardware

- Replacement hardware for use on 1418N4, 1418N4SS, 1447SN4, and 1447SN4SS Hammond enclosures.
- Formed heavy gauge stainless steel.
- Set of two.

<b>Part No.</b>	<b>1481HC18</b>
-----------------	-----------------



### Quick Release Clamp

- Provides fast access to conventional screw clamp type enclosures.
- Installs on clamp bracket in place of screw on 1418, 1418N4, 1447N4, and 1422N4 Series enclosures.
- Entire assembly is stainless steel.
- Set of two.

<b>Part No.</b>	<b>1418QR</b>
-----------------	---------------



1481C14 (Two screws included - not shown)



1481C18

### Door Clamping Hardware

- Replacement hardware for use on 1414, 1418, 1485, 1486, and 1487 Hammond enclosures.
- Formed heavy gauge stainless steel.

Part No.	Description
<b>1481C14</b>	Set of 2 for 1414, 1486, 1487 Series
<b>1481C18</b>	Set of 2 for 1418 Series

### Lifting or Pull Handles

- Chrome plated steel accessory handles.
- Two 10-32 screws on 1427L, M, and N; 6-32 screws on 1427P and Q.

Part No.	Mtg. Centers	Handle Diameter
<b>1427L</b>	7.00	.375
<b>1427M</b>	5.25	.375
<b>1427N</b>	3.50	.375
<b>1427P</b>	2.81	.250
<b>1427Q</b>	2.25	.250



### Pull Ring Catch

- Neat semi-flush pull ring catch.
- Chrome plated die cast.
- For use on flat plate cabinet doors eg. 1420 enclosures (not prepunched).

<b>Part No.</b>	<b>1427EK</b>
-----------------	---------------



### Latch Kits for Single Door Type 12 Enclosures

- Designed for field installation on most 1418 Series single door freestanding enclosures (does not fit 1418 J Series).
- Comes standard on wallmount versions - can be used as replacement hardware.
- Available with key locking, padlocking, and non-locking handles.
- Single point kits include a handle and latch cam.
- Latch rod ends have rollers for easier door closing.
- Three point kits include a handle, latch cam, latch rods and adjustable rod guides.
- All parts are plated or painted for corrosion resistance.

Non-Locking Handle	Handle Rotation	Locking Handle	Handle Rotation	Padlocking Handle	"Tee" Locking Handle	Description
AHK1	Clockwise	AHKL1	Counter Clockwise	PHK1	THK1	1 Point Latch
AHK2	Clockwise	AHKL2	Counter Clockwise	PHK2	THK2	3 Point Latch 48" and under
AHK3	Clockwise	AHKL3	Counter Clockwise	PHK3	THK3	3 Point Latch 60" and over



AHK1



AHKL1



PHK1



THK1

### Lock Kit for NEMA 1 Enclosures

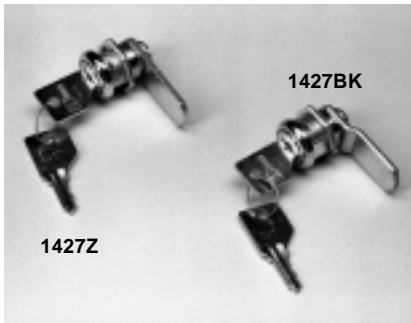

1427Z

1427BK



1427LKN1

- Installs in place of the existing slotted latch, or in cutout hole provided.
- Reversible cam position for other applications.
- Maintains NEMA rating.

Part No.	Fits Enclosure Series
1427LKN1	1420, N1A
1427BK	1439 Flush Mount
1427Z	1439 Surface Mount Kit



### Lock Kit for 1418 Type 4 and 12 Enclosures

- Designed for installation on most 1418 Series single door enclosures (does not fit 1418 J Series).
- Requires a drilled or punched hole to receive cylinder lock.
- Internal "O" ring provides dust and water tight construction.
- Maintains NEMA rating.

Part No.	1427LKN4

# General Accessories

## Hardware



Part No.	Description
<b>1421</b>	pkg. of 4 screws & 4 washers

Nickel plated 10-32 x 0.63" combo slot, Phillips oval countersunk head screws with steel cup washers.

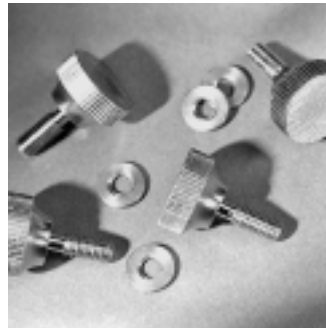

Part No.	Description
<b>1421B</b>	pkg. of 4 screws & 4 washers

Nickel plated 10-32 x 0.5" thumb screws with nylon washers for captivating panels up to 0.09" thick. Head is 0.62" diameter x 0.37" high.



Part No.	Description
<b>1421A</b>	pkg. of 4 screws & 4 washers

Nickel plated 10-32 x 0.63" combo slot, Phillips oval countersunk head screws with plastic cup washers.



Part No.	Description
<b>1421B2</b>	pkg. of 2 screws, nuts & washers

Polished stainless steel 1/4-20 x 0.87" thumb screws with nylon washers and steel nuts for captivating panels up to 0.4" thick. Head is 0.68" diameter x 0.25" high.



Part No.	Description
<b>1421A25B</b>	pkg. of 25
<b>1421A100B</b>	pkg. of 100

Nickel plated 10-32 x 0.63" combo slot, Phillips oval countersunk head screws.



Part No.	Description
<b>1421D</b>	pkg. of 25

Zinc plated 10-32 x 0.5" slotted pan head screws.



Part No.	Description
<b>1421A25W</b>	pkg. of 25
<b>1421A100W</b>	pkg. of 100

Black plastic cup washers for countersunk 10-32 screws.

## General Accessories

### Hardware

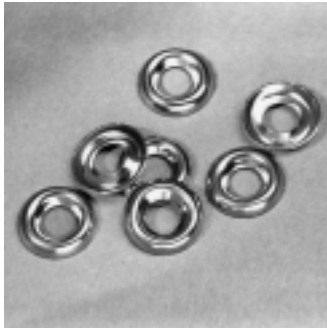

Part No.	Description
<b>1421E25W</b>	pkg. of 25
<b>1421E100W</b>	pkg. of 100

Nickel plated metal cup washers for countersunk 10-32 screws.



Part No.	Description
<b>1421N25</b>	pkg. of 25
<b>1421N100</b>	pkg. of 100

10-32 clip nuts for all panel rails and most other mounting positions. Has the holding strength of a standard 10-32 nut.



Part No.	Description
<b>1421F25</b>	pkg. of 25

Stainless steel 10-32 x 1.25" Phillips oval countersunk head (the extra length is necessary for **raised** panels).



Part No.	Description
<b>1421NP25</b>	pkg. of 25
<b>1421NP100</b>	pkg. of 100

Zinc plated 10-32 clip nuts. 10-32 clip nuts for all panel rails and most other mounting positions. Has the holding strength of a standard 10-32 nut.



Part No.	Description
<b>1463S</b>	pkg. of 3

$\frac{3}{8}$ -16 spring loaded nuts and  $\frac{3}{8}$ -16 x 0.75" bolts for "C" channels.



Part No.	Description
<b>1421S</b>	pkg. of 4

$\frac{1}{4}$ -20 spring loaded nuts and  $\frac{1}{4}$ -20 x 0.62" round head bolts for "C" channels.

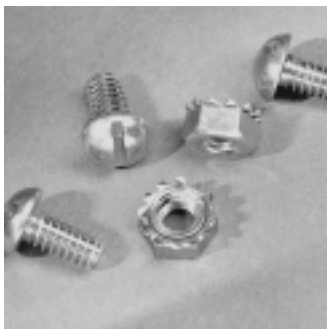

Part No.	Description
<b>1421K25</b>	pkg. of 25 screws & nuts
<b>1421K100</b>	pkg. of 100 screws & nuts

Zinc plated  $\frac{1}{4}$ -20 x 0.5" slotted round head screws with captive star washer nuts. Supplied with all panel rails and racks.

# General Accessories

## Hardware

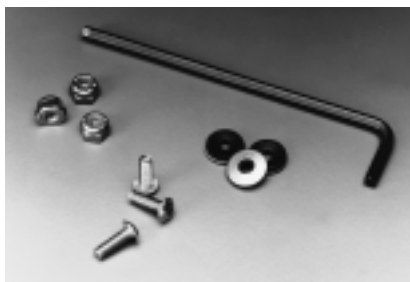

### UL/CSA Hardware Kits

- When used as instructed, kits maintain the UL/CSA Type rating of Hammond enclosures which unapproved hardware will not.
- Kit includes 50 stainless steel screws, sealing washers and nuts with one hex driver per kit.
- Screws require hex driver making them virtually tamper proof.
- Offered in  $\frac{8}{32}$ ,  $\frac{10}{32}$  and  $\frac{1}{4}$ -20 at various lengths.

Part No.	Description
1421N4AA50	8-32 x $\frac{1}{2}$ " Kit
1421N4AB50	8-32 x 1" Kit
1421N4BA50	10-32 x $\frac{1}{2}$ " Kit
1421N4BB50	10-32 x 1" Kit
1421N4CA50	$\frac{1}{4}$ -20 x $\frac{5}{8}$ " Kit
1421N4CB50	$\frac{1}{4}$ -20 x 1" Kit



### Quarter Turn Inserts and Keys

- For Eclipse and Services 2000 Enclosures
- Field installable inserts replace standard quarter turn slot.
- Available in 7mm square and triangle formats, as well as slotted.
- Square and triangle inserts provide extra security since standard screw drivers cannot open.
- Keys sold separately from inserts.
- Maintains NEMA, UL and CSA 12, 4 and 4X ratings.

Part No.	Description
2SQI7	7mm square insert, black
2SQK7	7mm square key, fits 2SQI7
2TRI7	7mm triangle insert, black
2TRK7	7mm triangle key, fits 2TRI7
2SLI	Slotted insert, black

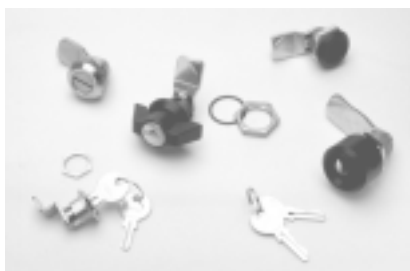

### Replacement Quarter Turn Assemblies

- Field installable.
- Interchangeable with standard quarter turn latches on Eclipse and Series 2000.
- Maintains NEMA, UL and CSA ratings as noted.

Part No.	Description	Material	NEMA Rating
EQTRL <sup>1</sup>	Locking Qtr Turn	Zinc Die/Chrome	n/a (internal use only)
2QTR	Slotted Qtr Turn	Zinc Die/Black	12, 4,
2SSQTR	Slotted Qtr Turn	Stainless steel	12, 4, 4X
2WKL	Wing knob lock	Zinc Die/Black	12, 4,
2QPL	Padlockable quarter turn latch	Zinc Die/Black	12, 4,
EJQTR	Slotted Qtr Turn	Zinc Die/Black	12, 4
EJSSQTR	Slotted Qtr Turn	Stainless Steel	12, 4, 4X

<sup>1</sup> For use with Swing Frame/Panel. All others for use with enclosures.

### Eclipse Padlock Adaptor

- For use with EN4SD Series Enclosures.
- Padlock adaptor fits directly over the slotted quarter turn preventing access.
- 14 gauge 304 stainless steel.
- Stainless steel mounting hardware provided
- Once installed, the bolts cannot be removed without the door open.
- Easy installed in the field.
- Padlock not included.
- Maintains UL/CSA Type 4 rating.

Part No.	EPA
----------	-----



Technical references and DXF downloads available at [www.hammmfg.com](http://www.hammmfg.com)

All dimensions in inches unless specified otherwise

## General Accessories

### Hardware

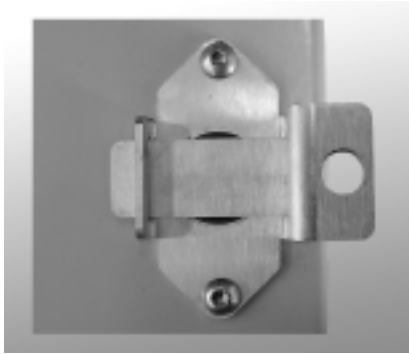

#### Eclipse Junior Padlock Adaptor

- Padlock adapter fits directly over the slotted quarter turn preventing access.
- 2mm thick 14 gauge stainless steel.
- Stainless steel mounting hardware provided.
- Once installed, the bolts cannot be removed without the door open.
- Easy installed in the field.
- Padlock not included.
- Maintains UL/CSA Type 4 rating.

Part No.	EJPA
----------	------



#### Eclipse Junior Wing Knob

- For use with EJ Series only.
- Installs in place of the standard quarter turn lock.
- Internal "O" ring provides dust and water tight construction.
- Zinc Diecast/Black
- Maintains UL/CSA Type 4 rating.

Part No.	EJWKL
----------	-------

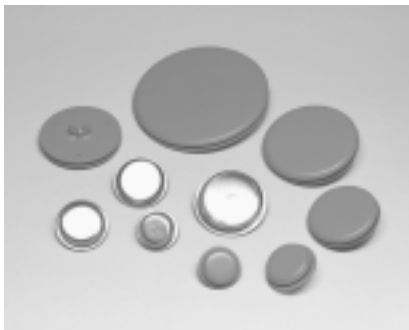

#### Oil Tight Hole Plugs

- Designed to seal unused pushbutton holes, conduit openings and knockout holes against dust, oil and water.
- Standard Pushbutton size is 30.5mm

#### Steel Hole Plugs

- Available in 12 sizes.
- Finished in gray.
- Oil resistant gasket.
- Secured with an 8-32 x 3/4" threaded stud and plated wing nut.

#### Stainless Steel Hole Plugs

- Available in 8 sizes.
- Finished in brushed natural stainless finish.
- Oil resistant gasket.
- Secured with an 8-32 x 3/4" threaded stud and plated wing nut.

#### Hole Plugs - Steel

Part No.	Description	Diameter
HP22	22mm Pushbutton	1.22
HP50	.5" Conduit	1.38
HP75	.75" Conduit	1.63
HPB	Std. Pushbutton	1.75
HP100	1" Conduit	1.88
HP125	1.25" Conduit	2.25
HP150	1.5" Conduit	2.50
HP200	2" Conduit	3.00
HP250	2.5" Conduit	3.50
HP300	3" Conduit	4.14
HP350	3.5" Conduit	4.66
HP400	4" Conduit	5.19

#### Hole Plugs - Stainless Steel

Part No.	Description	Diameter
HP22SS	22mm Pushbutton	1.22
HP50SS	.5" Conduit	1.38
HP75SS	.75" Conduit	1.63
HPBSS	Std. Pushbutton	1.75
HP100SS	1" Conduit	1.88
HP125SS	1.25" Conduit	2.25
HP150SS	1.5" Conduit	2.50
HP200SS	2" Conduit	3.00



# General Accessories

## Panels & Panel Accessories

### Panels for 1414, EJ and PJ Series Enclosures

- 14 gauge steel panels are finished in white.
- Aluminum panels are 0.080 type 5052 H-32 aluminum, unpainted.
- 14 gauge unpainted galvanized steel.
- Steel panels and mounting hardware are included with 1414 Series enclosures.
- Galvanized panels and mounting hardware are included with the EJ Series enclosures.
- Mounting hardware is included with PJ Series enclosures, order panel separately.

Steel Part No.	Aluminum Part No.	Galv. Steel Part No.	Panel		For Use With 1414 and EJ		For Use With PJ Series	
			Length	Width	Height	Width	Height	Width
14R0503		14G0503	4.88	2.88	6	4	—	—
14R0505	14A0505	14G0505	4.88	4.88	6	6	7.04	7.04
14R0705	14A0705	14G0705	6.75	4.88	8	6	8.94	7.06
14R0707		14G0707	6.75	6.88	8	8	—	—
14R0907	14A0907	14G0907	8.75	6.88	10	8	11.08	9.20
14R0909		14G0909	8.75	8.88	10	10	—	—
14R1105		14G1105	10.75	4.88	12	6	—	—
14R1109	14A1109	14G1109	10.75	8.88	12	10	13.08	11.20
14R1111		14G1111	10.75	10.88	12	12	—	—
14R1307		14G1307	12.75	6.88	14	8	—	—
14R1311	14A1311	14G1311	12.75	10.88	14	12	15.08	13.20
14R1509		14G1509	14.75	8.88	16	10	—	—
14R1513	14A1513	14G1513	14.75	12.88	16	14	17.22	15.34
P1868	A1868		16.88	14.88	—	—	19.34	17.34
P2068	A2068		18.44	14.44	—	—	20.94	16.94

### Panels for 1418, 1422, 1447, and Series 2000 Wallmount Enclosures

- 12 gauge steel finished in white.
- Larger panels have two or four formed flanges.
- Some larger panels are 10 gauge.
- Panels and mounting hardware are included with 1418, 1447 and 1422 Series enclosures.
- Mounting hardware is included with Series 2000 enclosures, order panel separately.

Part No.	Panel		For Use With Enclosure	
	Length	Width	Height	Width
18P0909 <sup>1</sup>	9	9	12	12
18P0921 <sup>2</sup>	9	21	12	24
18P1309 <sup>1</sup>	13	9	16	12
18P1313 <sup>1</sup>	13	13	16	16
18P1709 <sup>1</sup>	17	9	20	12
18P1713 <sup>1</sup>	17	13	20	16
18P1717 <sup>1</sup>	17	17	20	20
18P2113 <sup>2</sup>	21	13	24	16
18P2117 <sup>2</sup>	21	17	24	20
18P2121 <sup>3</sup>	21	21	24	24
18P2709 <sup>2</sup>	27	9	30	12
18P2713 <sup>2</sup>	27	13	30	16
18P2717 <sup>2</sup>	27	17	30	20
18P2721 <sup>3</sup>	27	21	30	24
18P2727 <sup>3</sup>	27	27	30	30
18P3321 <sup>3</sup>	33	21	36	24
18P3327 <sup>3</sup>	33	27	36	30
18P3333 <sup>3</sup>	33	33	36	36
18P3921 <sup>3</sup>	39	21	42	24
18P3927 <sup>3</sup>	39	27	42	30
18P3933 <sup>3</sup>	39	33	42	36
18P4521 <sup>3</sup>	45	21	48	24
18P4527 <sup>3</sup>	45	27	48	30
18P4533 <sup>3</sup>	45	33	48	36
18P5733 <sup>3</sup>	57	33	60	36
18P6927 <sup>3</sup>	69	27	72	30
18P6933 <sup>3</sup>	69	33	72	36

<sup>1</sup> Flat Panel    <sup>2</sup> 2 Formed Flanges    <sup>3</sup> 4 Formed Flanges

# General Accessories

## Panels & Panel Accessories

### Panels for Eclipse Series Enclosures

- Larger than standard NEMA panel used in same sized enclosure.
- 12 or 14 gauge steel construction (see chart at right).
- Larger sizes have 2 or 4 formed flanges for added strength.
- Slotted corner design for easier mounting.
- Finished in white or unpainted galvanized.

Size					Size				
Mild Steel	Galvanized	D	E	Gauge	Mild Steel	Galvanized	D	E	Gauge
EP1212 <sup>1</sup>	EPG1212 <sup>1</sup>	10.2	10.2	14	EP3024 <sup>3</sup>	EPG3024 <sup>3</sup>	28.2	22.2	12
EP1612 <sup>1</sup>	EPG1612 <sup>1</sup>	14.2	10.2	14	EP3030 <sup>3</sup>	EPG3030 <sup>3</sup>	28.2	28.2	12
EP1616 <sup>1</sup>	EPG1616 <sup>1</sup>	14.2	14.2	12	EP3048 <sup>3</sup>	EPG3048 <sup>3</sup>	28.2	46.2	12
EP1620 <sup>1</sup>	EPG1620 <sup>1</sup>	14.2	18.2	12	EP3060 <sup>3</sup>	EPG3060 <sup>3</sup>	28.2	58.2	12
EP2016 <sup>1</sup>	EPG2016 <sup>1</sup>	18.2	14.2	12	EP3624 <sup>3</sup>	EPG3624 <sup>3</sup>	34.2	22.2	12
EP2020 <sup>2</sup>	EPG2020 <sup>2</sup>	18.2	18.2	12	EP3630 <sup>3</sup>	EPG3630 <sup>3</sup>	34.2	28.2	12
EP2024 <sup>2</sup>	EPG2024 <sup>2</sup>	18.2	22.2	12	EP3636 <sup>3</sup>	EPG3636 <sup>3</sup>	34.2	34.2	12
EP2416 <sup>2</sup>	EPG2416 <sup>2</sup>	22.2	14.2	12	EP3648 <sup>3</sup>	EPG3648 <sup>3</sup>	34.2	46.2	12
EP2420 <sup>2</sup>	EPG2420 <sup>2</sup>	22.2	18.2	12	EP3660 <sup>3</sup>	EPG3660 <sup>3</sup>	34.2	58.2	12
EP2424 <sup>3</sup>	EPG2424 <sup>3</sup>	22.2	22.2	12	EP4236 <sup>3</sup>	EPG4236 <sup>3</sup>	40.2	34.2	12
EP2430 <sup>3</sup>	EPG2430 <sup>3</sup>	22.2	28.2	12	EP4824 <sup>3</sup>	EPG4824 <sup>3</sup>	46.2	22.2	12
EP2442 <sup>3</sup>	EPG2442 <sup>3</sup>	22.2	40.2	12	EP4836 <sup>3</sup>	EPG4836 <sup>3</sup>	46.2	34.2	12
EP3020 <sup>3</sup>	EPG3020 <sup>3</sup>	28.2	18.2	12	EP6036 <sup>3</sup>	EPG6036 <sup>3</sup>	58.2	34.2	12

<sup>1</sup> Flat Panel    <sup>2</sup> 2 Formed Flanges    <sup>3</sup> 4 Formed Flanges

### Panels for 1420 Series Enclosures

- 12 gauge steel finished in white.
- Panels and mounting hardware are included with 1420 Series enclosures.

Part No.	Panel		For Use With Enclosure	
	Length	Width	Height	Width
20P1410 <sup>1</sup>	14	10	16	12
20P1814 <sup>1</sup>	18	14	20	16
20P1818 <sup>1</sup>	18	18	20	20
20P2218	22	18	24	20
20P2222	22	22	24	24
20P2818	28	18	30	20
20P2822	28	22	30	24
20P3422	34	22	36	24
20P3428	34	28	36	30
20P4022	40	22	42	24
20P4028	40	28	42	30
20P4034	40	34	42	36
20P4634	46	34	48	36

<sup>1</sup> Flat panel

### Panels for 1422 Series Floormount Enclosures

- 22P5038 is formed from 12 gauge steel, all others are 10 gauge steel.
- Panels and mounting hardware are included with 1422 Series enclosures.
- Finished in white.

Part No.	Panel		For Use With Enclosure	
	Length	Width	Height	Width
22P5038	50	38	54	42
22P5644	56	44	60	48
22P5656	56	56	60	60
22P6856	68	56	72	60
22P6868	68	68	72	72

# General Accessories

## Panels & Panel Accessories

### Panels for N1A Series Enclosures

- 14 gauge steel finished in white.
- Panels and mounting hardware are included with NIA Series enclosures.

Part No.	Panel		For Use With Enclosure	
	Length	Width	Height	Width
AP1612 <sup>1</sup>	13	10.5	16	12
AP1616 <sup>1</sup>	13	14.5	16	16
AP1620 <sup>1</sup>	13	18.5	16	20
AP2016 <sup>1</sup>	17	14.5	20	16
AP2020 <sup>1</sup>	17	18.5	20	20
AP2024 <sup>1</sup>	17	22.5	20	24
AP2416 <sup>1</sup>	21	14.5	24	16
AP2420 <sup>1</sup>	21	18.5	24	20
AP2424 <sup>1</sup>	21	22.5	24	24
AP3020 <sup>1</sup>	26	18.5	30	20
AP3024 <sup>1</sup>	26	22.5	30	24
AP3030 <sup>1</sup>	26	28.5	30	30
AP3624 <sup>1</sup>	32	22.5	36	24
AP3630 <sup>1</sup>	32	28.5	36	30
AP4224 <sup>1</sup>	38	22.5	42	24
AP4230	38	28.5	45	30
AP4236	38	34.5	42	36
AP4836	44	34.5	48	36

<sup>1</sup> Flat Panel



### Terminal Kits for 1414/EJ/PJ Series Enclosures

- Used to provide convenient mounting for terminal blocks in 1414 Series enclosures and some sizes of "PJ" Series enclosures.
- Finished in white.

#### How to Order

- Each enclosure requires one bracket assembly kit and the required number of straps (Strap Part No. corresponds to enclosure dimension "A" and is mounted parallel to same, Bracket Part No. corresponds to enclosure dimension "B" and is mounted parallel to same).
- Example: For a PJ864L enclosure, order one 14B6 bracket assembly and a minimum of one 14B8 terminal strap kits. Additional terminal strap kits will provide additional mounting space.

#### Bracket Assembly

- Each kit consists of two brackets.
- "C" channel construction provides easy alignment of terminal straps.

#### Terminal Strap

- 1.5" wide x 0.187" thick steel.
- Each strap includes spring locking hardware.
- Countersunk holes in straps provide extra terminal mounting space.

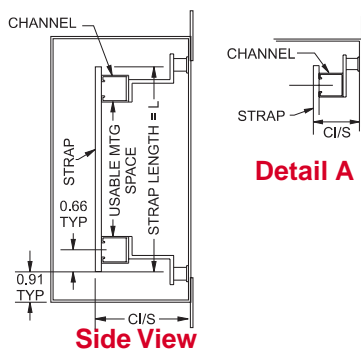
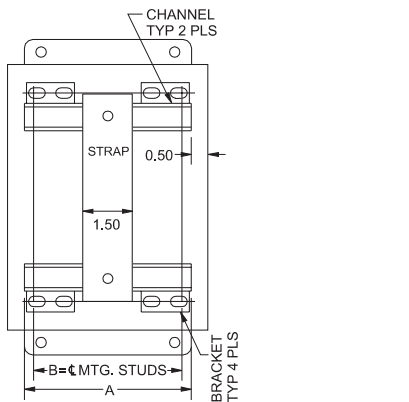

**Detail A**

Single Strap Part No.	Usable L= Length	Mounting Space	Bracket (Pair) Part No.	Width of Box	A	B	C	Fits PJ Enclosure
14S8	6.19	4.30	14B6	6	5	4.25	1.55	PJ864... <sup>1</sup>
14S10	8.19	6.30	14B8	8	7	6.25	1.55	PJ1086... <sup>1</sup>
14S12	10.19	8.30	14B10	10	9	8.25	2.79	PJ12106... <sup>1</sup>
14S14	12.19	10.30	14B12	12	11	10.25	2.79	PJ14126... <sup>1</sup>
14S16	14.19	12.30	14B14	14	13	12.25	2.79	PJ16148... <sup>1</sup>

<sup>1</sup> Compatible with all latch types

# General Accessories

## Panels & Panel Accessories



### Bracket Assembly

Part No.	# of Brackets	Length	Parallel Enclosure Dim	
			B	Dim
18B212	2	8.5	7.25	12
18B216	2	12.5	11.25	16
18B220	2	16.5	15.25	20
18B224	2	20.5	19.25	24
18B324	3	20.5	19.25	24
18B230	2	26.5	25.25	30
18B330	3	26.5	25.25	30
18B236	2	32.5	31.25	36
18B336	3	32.5	31.25	36

### Strap

Part No.	Length	Usable Mounting Space (L)
18S12	9.5	7.6
18S16	13.5	11.6
18S20	17.5	15.6
18S24	21.5	19.6
18S30	27.5	25.6
18S36	33.5	31.6
18S42	39.5	37.6
18S48	45.5	43.6
18S60	57.5	55.6
18S72	69.5	67.6

### Terminal Kit for 1418/Series 2000 Enclosures

- Used to provide convenient mounting for terminal blocks, pneumatic controls or small relays in 1418/ Series 2000 wallmount enclosures.
- Brackets may be installed horizontally or vertically in an enclosure if the size corresponds to enclosure length or width.
- Finished in white.

### Bracket Assembly

- Each kit consists of two or three brackets per assembly.
- Brackets combined with collar stud length provide 3" minimum clearance from the rear of the enclosure.
- "C" channel construction provides easy alignment of terminal straps.

### Terminal Strap

- 1.5" wide x 0.187" thick steel.
- Each strap includes spring locking hardware.
- Countersunk holes in straps provide extra terminal mounting space.

### How To Order

- Each enclosure requires one bracket assembly kit and the required number of straps (order separately).
- Determine if strap will be mounted parallel to dimension "A" or "B".
- Choose the part number that corresponds to enclosure dimensions "A" or "B".
- When choosing a bracket assembly to be parallel to dimension "B" in an enclosure of 24", 30" or 36" width, determine if a two or three bracket assembly is required. When enclosures are 48" or greater on "A" dimension, 6 collar studs are used.
- Choose strap kit to correspond to the other enclosure dimensions.
- Order the number of kits equal to the number of straps required.

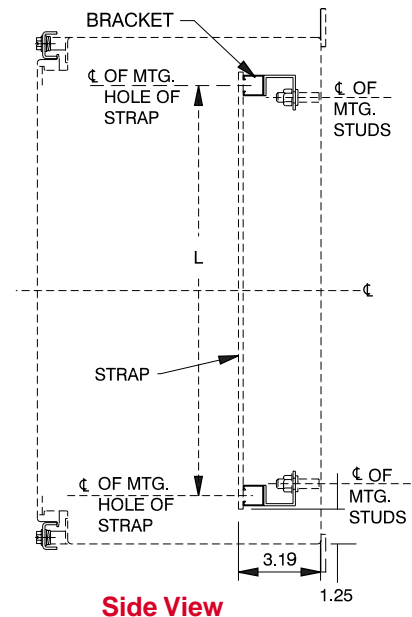
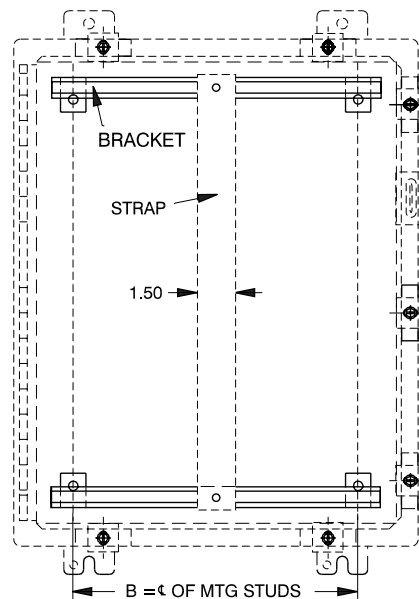

Side View

# General Accessories

## Power Bars



Front View



Rear View



### Rail Mount, Rear Outlet Power Bar

- Designed for rear access with a lighted, rocker type ON-OFF switch for master power shut-off/on where noted in chart.
- Heavy 14 gauge wire cord - 14/3 SJTW for extreme temperature ranges and integral molded plug.
- Contains 6 receptacles, a 15 Amp breaker and is rated for 15 Amps @ 125V.
- Steel case, U-ground cord, plug, and receptacles.
- Power bar is 19" wide, 3" deep and requires 1 unit (1.75") of panel height to mount.
- UL component recognized.
- CSA approved.
- Available in satin black or ASA 61 gray.

Part No.	Color	Cord Length	On/Off Switch	Type	No. of Outlets
1583H6A1BK	Black	6'	Yes	Straight	6
1583H6B1BK	Black	15'	Yes	Straight	6
1583H6C1BK	Black	6'	Yes	Twist-Lock	6
1583H6A1SBK <sup>1</sup>	Black	6'	Yes	Straight	6
1583H8A1BK	Black	6'	Yes	Straight	8
1583H8B1BK	Black	15'	Yes	Straight	8
1583H8C1BK	Black	6'	Yes	Twist-Lock	8
1583T6A1BK	Black	6'	No	Straight	6
1583T6B1BK	Black	15'	No	Straight	6
1583T6C1BK	Black	6'	No	Twist-Lock	6
1583T8A1BK	Black	6'	No	Straight	8
1583T8B1BK	Black	15'	No	Straight	8
1583T8C1BK	Black	6'	No	Twist-Lock	8

<sup>1</sup> Surge Protected

General Accessories



### Rail Mount, Front Outlet Power Bar

- Designed for front access with a lighted, rocker type ON-OFF switch for master power shut-off/on where noted in chart.
- Heavy 14 gauge wire cord - 14/3 SJTW for extreme temperature ranges and integral molded plug.
- Contains 6 or 8 receptacles, a 15 Amp breaker and is rated for 15 Amps @ 125V.
- Steel case, U-ground cord, plug, and receptacles.
- Power bar is 19" wide, 3" deep and requires 1 unit (1.75") of panel height to mount.
- UL component recognized.
- CSA approved.
- Available in satin black or ASA 61 gray.

Part No.	Color	Cord Length	On/Off Switch	Type	No. of Outlets
1582H6A1BK	Black	6'	Yes	Straight	6
1582H6B1BK	Black	15'	Yes	Straight	6
1582H6C1BK	Black	6'	Yes	Twist-lock	6
1582H6A1SBK <sup>1</sup>	Black	6'	Yes	Straight	6
1582H8A1BK	Black	6'	Yes	Straight	8
1582H8B1BK	Black	15'	Yes	Straight	8
1582H8C1BK	Black	6'	Yes	Twist-lock	8
1582T6A1BK	Black	6'	No	Straight	6
1582T6B1BK	Black	15'	No	Straight	6
1582T6C1BK	Black	6'	No	Twist-lock	6
1582T8A1BK	Black	6'	No	Straight	8
1582T8B1BK	Black	15'	No	Straight	8
1582T8C1BK	Black	6'	No	Twist-lock	8

<sup>1</sup> Surge Protected

## General Accessories

### Power Bars



#### Heavy Duty Power Bar

- Built to meet the rugged requirements of commercial and industrial use.
- All metal housing - tough extruded aluminum case with a matte black steel cover and heavy duty duplex receptacles.
- Heavy 14 gauge wire cord - 14/3 SJTW for extreme temperature ranges and integral molded plug.
- UL/CSA approved.
- Plug types available are NEMA 5-15P straight blade or NEMA L5-15P twist-lock.
- Separate mounting feet provide for work station mounting if desired.
- Contains 15 amp, 125 volt re-settable circuit breakers to prevent accidental line overload.
- Available in 3 lengths with 4, 6, or 8 receptacles.
- Features a lighted, rocker type ON-OFF switch for master power shut-off/on where noted in chart.



#### Rack Mounting Kit

- Contains hardware for system and Amhal strut mounting.

Part No.	1584MK1
----------	---------

Part No.	No. of Outlets	Length (Inches) <sup>1</sup>	On/Off Switch	Cord Length	Cord Type
1584H4A1	4	10.0	Yes	6'	Straight
1584H4B1	4	10.0	Yes	15'	Straight
1584H4C1	4	10.0	Yes	6'	Twist-Lock
1584H4D1	4	10.0	Yes	15'	Twist-Lock
1584H5A1	5	13.0	Yes	6'	Straight
1584H5B1	5	13.0	Yes	15'	Straight
1584H5C1	5	13.0	Yes	6'	Twist-Lock
1584H5D1	5	13.0	Yes	15'	Twist-Lock
1584H6A1	6	13.0	Yes	6'	Straight
1584H6B1	6	13.0	Yes	15'	Straight
1584H6C1	6	13.0	Yes	6'	Twist-Lock
1584H6D1	6	13.0	Yes	15'	Twist-Lock
1584H7A1	7	13.0	Yes	6'	Straight
1584H7B1	7	13.0	Yes	15'	Straight
1584H7C1	7	13.0	Yes	6'	Twist-Lock
1584H7D1	7	13.0	Yes	15'	Twist-Lock
1584H8A1	8	16.5	Yes	6'	Straight
1584H8B1	8	16.5	Yes	15'	Straight
1584H8C1	8	16.6	Yes	6'	Twist-Lock
1584H8D1	8	16.6	Yes	15'	Twist-Lock
1584T4A1	4	10.0	No	6'	Straight
1584T4B1	4	10.0	No	15'	Straight
1584T4C1	4	10.0	No	6'	Twist-Lock
1584T4D1	4	10.0	No	15'	Twist-Lock
1584T5A1	5	13.0	No	6'	Straight
1584T5B1	5	13.0	No	15'	Straight
1584T5C1	5	13.0	No	6'	Twist-Lock
1584T5D1	5	13.0	No	15'	Twist-Lock
1584T6A1	6	13.0	No	6'	Straight
1584T6B1	6	13.0	No	15'	Straight
1584T6C1	6	13.0	No	6'	Twist-Lock
1584T6D1	6	13.0	No	15'	Twist-Lock
1584T7A1	7	16.5	No	6'	Straight
1584T7B1	7	16.5	No	15'	Straight
1584T7C1	7	16.5	No	6'	Twist-Lock
1584T7D1	7	16.5	No	15'	Twist-Lock
1584T8A1	8	16.5	No	6'	Straight
1584T8B1	8	16.5	No	15'	Straight
1584T8C1	8	16.5	No	6'	Twist-Lock
1584T8D1	8	16.5	No	15'	Twist-Lock

<sup>1</sup>This is the length of the actual power bar. In addition, there are 0.5 mounting feet on each end, adding an total of 1" to overall length.

# General Accessories

## General Accessories

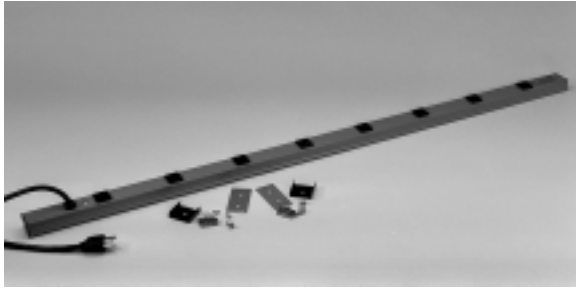

### 1585 Vertical Power Strip

- 1 5/8" X 1 3/8" aluminum profiles.
- Heavy 14 gauge wire cord - 14/3 SJTW for extreme temperature ranges and integral molded plug.
- UL/CSA approved.
- Plug types available are NEMA 5-15P straight blade or NEMA L5-15P twist-lock.
- Rated for 15 Amps @ 125V.
- Ready to mount, vertical power distribution for 19/24" cabinets.
- Mounting clips are included for easy mounting to Amhal struts in any location. Replacement clips are available.
- Complete with 6 or 15 foot cord.
- Solid aluminum extrusion.
- 8, 10 and 12 outlet units available.

### 1589 Vertical Power Strip

- construction as noted above with:
  - 12 gauge wire
  - 20 amp power cord and circuit breaker
  - Plug types available are Nema L5-20P twist-lock or Nema 5-20P straight blade.

Part No.	No. of Outlets	Length (Inches) <sup>1</sup>	Switch	Cord Length	Cord Type
1589T36C1	6	36"	No	6'	Twist-Lock
1589T36F1	6	42"	No	6'	Straight
1589T42C1	7	42"	No	6'	Twist-Lock
1589T42F1	7	42"	No	6'	Straight
1589T48C1	8	48"	No	6'	Twist-Lock
1589T48F1	8	48"	No	6'	Straight
1589T60C1	10	60"	No	6'	Twist-Lock
1589T60F1	10	60"	No	6'	Straight
1589T70C1	10	70"	No	6'	Twist-Lock
1589T70F1	10	70"	No	6'	Straight
1589T77C1	12	77"	No	6'	Twist-Lock
1589T77F1	12	77"	No	6'	Straight

Part No.	No. of Outlets	Length (Inches) <sup>1</sup>	On/Off Switch	Cord Length	Cord Type
15851H6A1	6	18	Yes	6'	Straight
15851H6B1	6	18	Yes	15'	Straight
15851H6C1	6	18	Yes	6'	Twist-Lock
15852H6A1	6	24	Yes	6'	Straight
15852H6B1	6	24	Yes	15'	Straight
15852H6C1	6	24	Yes	6'	Twist-Lock
15853H6A1	6	36	Yes	6'	Straight
15853H6B1	6	36	Yes	15'	Straight
15853H6C1	6	36	Yes	6'	Twist-Lock
15854H7A1	7	42	Yes	6'	Straight
15854H7B1	7	42	Yes	15'	Straight
15854H7C1	7	42	Yes	6'	Twist-Lock
1585H8A1	8	48	Yes	6'	Straight
1585H8B1	8	48	Yes	15'	Straight
1585H8C1	8	48	Yes	6'	Twist-Lock
1586H10A1	10	60	Yes	6'	Straight
1586H10B1	10	60	Yes	15'	Straight
1586H10C1	10	60	Yes	6'	Twist-Lock
1587H10A1	10	70	Yes	6'	Straight
1587H10B1	10	70	Yes	15'	Straight
1587H10C1	10	70	Yes	6'	Twist-Lock
1588H12A1	12	77	Yes	6'	Straight
1588H12B1	12	77	Yes	15'	Straight
1588H12C1	12	77	Yes	6'	Twist-Lock
15851T6A1	6	18	No	6'	Straight
15851T6B1	6	18	No	15'	Straight
15851T6C1	6	18	No	6'	Twist-Lock
15852T6A1	6	24	No	6'	Straight
15852T6B1	6	24	No	15'	Straight
15852T6C1	6	24	No	6'	Twist-Lock
15853T6A1	6	36	No	6'	Straight
15853T6B1	6	36	No	15'	Straight
15853T6C1	6	36	No	6'	Twist-Lock
15854T7A1	7	42	No	6'	Straight
15854T7B1	7	42	No	15'	Straight
15854T7C1	7	42	No	6'	Twist-Lock
1585T8A1	8	48	No	6'	Straight
1585T8B1	8	48	No	15'	Straight
1585T8C1	8	48	No	6'	Twist-Lock
1586T10A1	10	60	No	6'	Straight
1586T10B1	10	60	No	15'	Straight
1586T10C1	10	60	No	6'	Twist-Lock
1587T10A1	10	70	No	6'	Straight
1587T10B1	10	70	No	15'	Straight
1587T10C1	10	70	No	6'	Twist-Lock
1588T12A1	12	77	No	6'	Straight
1588T12B1	12	77	No	15'	Straight
1588T12C1	12	77	No	6'	Twist-Lock

### Extra Mounting Clips

Part No.	1585CLIP



**Remote Receptacle**

- 125V/15A max. receptacle
- mounts to 35mm DIN rail (not included)
- 3.6"H x 2.4"W x 1.9"D
- CE, UL/cUL component recognized



**Part No. SSD03504001**



**Steel and Stainless Steel Window Kits**

- Designed to maintain environmental protection level of NEMA 12 stainless steel enclosures in indoor applications.
- Window is 0.25" thick, clear acrylic.
- Frame is heavy gauge steel, or 304 stainless steel with integral weld studs and compression clips.
- Oil resistant neoprene gasket ensures a watertight seal.
- Finished in gray or natural brushed stainless steel.

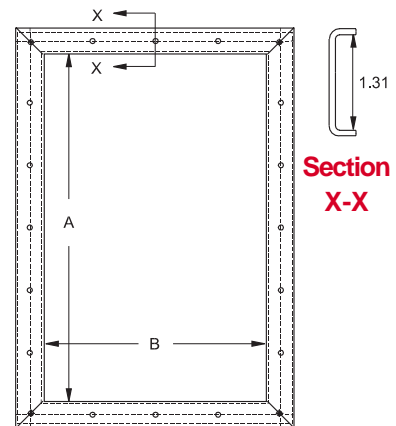

Part No.	Material	Window Dimensions		No. of Clips	Recommended Cut-Out Size	
		A	B			
1481W0503	Steel	5	3.0	6	6.69	4.69
1481W0905	Steel	9	5.5	10	10.69	7.69
1481W1303	Steel	13	3.0	10	14.69	4.69
1481W1308	Steel	13	8.0	14	14.69	9.69
1481W1705	Steel	17	5.5	16	18.69	7.69
1481W1711	Steel	17	11.0	20	18.69	12.69
1481W2315	Steel	23	15.0	24	24.69	16.69
1481W2919	Steel	29	19.0	30	30.69	20.69
1481W3523	Steel	35	23.0	36	36.69	24.69
1481WSS0503	Stainless Steel	5	3.0	6	6.69	4.69
1481WSS0905	Stainless Steel	9	5.5	10	10.69	7.69
1481WSS1308	Stainless Steel	13	8.0	14	14.69	9.69
1481WSS1711	Stainless Steel	17	11.0	20	18.69	12.69
1481WSS2315	Stainless Steel	23	15.0	24	24.69	16.69
1481WSS2919	Stainless Steel	29	19.0	30	30.69	20.69



# General Accessories

## General Accessories



### Flange Disconnect Operator Adaptor Kits

- Used to adapt flange mounted operating mechanisms to all Hammond enclosures with universal cutouts.
- Kits include an adaptor plate and all of the required parts (with instructions) to interlock the master door with the operator mechanism.
- Blank plates are used to cover the flange cutouts in Hammond universal type disconnect enclosures.

Part No.	Operator Make & Type		
<b>AKU</b>	<b>ABB Controls</b> - <i>operating handle</i>		
	Disconnect Switch	DSFHN-HS12	
	Circuit Breaker	K7FHD-HS12	
	<b>Allen Bradley</b> - <i>1494V variable depth operating handle</i>		
	Disconnect Switch		
	30 to 200	1494V H1	for 2UD, UHD/ UHDM
	400 to 600	1494V H2	for UHD
	400	1494V H2	for UHDM
	Circuit Breaker	1494V H11	
	<b>Cutler Hammer</b> - <i>operating handle</i>		
	Disconnect Switch	C361H1 or H3	
	Circuit Breaker		
	150 A	C371H1 or H3	
	250 to 600 A	C371H5 or H7	for 2UD
	250 to 1200 A	C371H5 or H7	for UHD/UHDM
	Circuit Breaker	C371 Flex-Shaft™	handle mechanism
	<b>General Electric</b> - <i>operating handle</i>		
	Disconnect Switch	STDA1or STDA2	
	Circuit Breaker	STDA1or STDA2	
	Circuit Breaker Spectra-Flex™ cable operators		
	150 to 600 A	STDA1	
	SK1200 A	STDA3	
	<b>I.T.E. Max-Flex™</b> - <i>operating handle</i>		
	Disconnect Switch variable depth	FHOHS	
	Circuit Breaker		
	125 to 600 A	FHOH	
	800 to 2000 A	FHOHN	
	<b>Square D</b> - <i>class 9422 operating mechanism</i>		
	Disconnect Switch variable depth	9422 type A1	
	Circuit Breaker variable depth	9422 type A1	
	Disconnect Switch with cable mechanism	9422 type A1	
	Circuit Breaker with cable mechanism	9422 type A1	
<b>AK1494FD</b>	<b>Allen Bradley</b>	1494F and D	
<b>BPAK</b>	Blank plate		

## General Accessories

### General Accessories

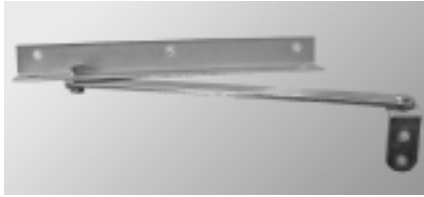

#### Door Stop Kit

- Provides for door opening in fixed position as required.
- Prevents door swing that can occur in field maintenance situations.
- This door stop kit maintains NEMA 4x, 4, 3R and 12 ratings when installed correctly using the hardware and directions provided.

Part No.	DSTOPK
----------	--------

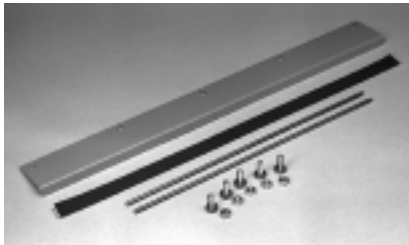

#### Drip Shield Kit

- Designed for use on Hammond NEMA 12 1418, and 1422 enclosures to protect door and hardware from falling dust and water.
- Cannot be used on NEMA 4 (mild steel or aluminum) or 4X due to interference with the top clamps on those units.
- Installs quickly and easily in the field with common tools.
- Each kit includes a drip shield, stainless steel bolts, plated nuts, neoprene gasket for drip shield and a stainless steel hinge pin (2 half length pins are supplied when required).
- Finished in gray.



Part No.	Fits Enclosure Width (Inches)
1481S12K	12
1481S16K	16
1481S20K	20
1481S24K	24
1481S30K	30
1481S36K	36
1481S42K	42
1481S48K	48
1481S60K	60
1481S72K	72



#### Light Kit & Accessories

- Light kits are offered in 18", 24" and 48" widths.
- CSA and UL component recognized.
- Features a manually operated switch, 115V convenience outlet, durable plastic lens, and 6 foot power cord (without plug).
- Can mount into light mounting channel, bolt through enclosure or by using magnet strip (available separately - see chart at right.)
- Magnet mount can be used with mild steel enclosures only.
- Remote door switch available separately for automatic activation (Part No. FLKDS). Can be wired normally open or closed. 115/230 V AC
- 1¾" high x 4½" deep.
- Finished in white.
- Use standard 18", 24" or 48" T12 fluorescent bulb (not included)

Part No.	Description
FLK18 <sup>1</sup>	18" Fluorescent Light Kit
FLK24 <sup>1</sup>	24" Fluorescent Light Kit
FLK48 <sup>1</sup>	48" Fluorescent Light Kit
FLK18MM	Magnet mount for 18" and 24" kit
FLK48MM	Magnet mount for 48" light kit
FLKDS	Remote Door Switch

<sup>1</sup> T12 fluorescent bulb not included

Remote door switch and magnet mount not included - must be ordered separately.



# General Accessories

## General Accessories



### Floor Stand Kit

- Kit includes two mounting feet and hardware kit.
- Finished in gray or natural brushed stainless steel.
- Pre-punched mounting feet may be used as a template to drill holes on bottom of enclosure.

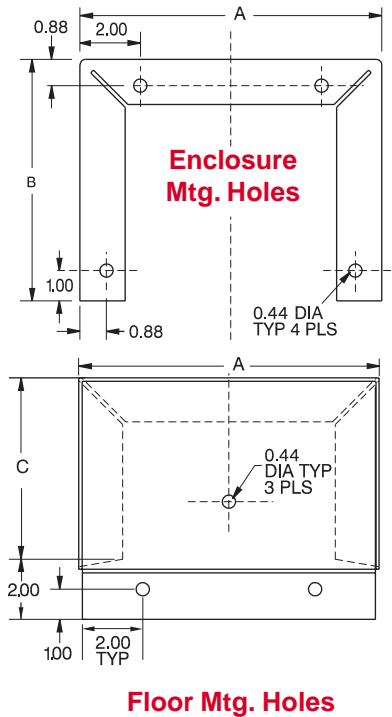

Steel Part No.	Stainless Steel Part No.	Foot Height	Enclosure Depth	Dimensions		
				A	B	C
1481FA8K		6	8	8	6	4
1481FA10K		6	10	10	8	6
1481FA12K		6	12	12	8	6
1481FA16K		6	16	16	10	8
1481FA18K		6	18	18	10	8
1481FA20K		6	20	20	10	8
1481FC6K		12	6	6	5	4
1481FC8K	1481FC8KSS	12	8	8	6	4
1481FC10K	1481FC10KSS	12	10	10	8	6
1481FC12K	1481FC12KSS	12	12	12	8	6
1481FC16K	1481FC16KSS	12	16	16	10	8
1481FC18K		12	18	18	10	8
1481FC20K		12	20	20	10	8
1481FC24K		12	24	24	10	8
1481FE6K		15	6	6	5	4
1481FE8K		15	8	8	6	4
1481FE10K		15	10	10	8	6
1481FE12K		15	12	12	8	6
1481FE16K		15	16	16	10	8
1481FE18K		15	18	18	10	8
1481FE24K		15	24	24	10	8
1481FG6K		18	6	6	5	4
1481FG8K		18	8	8	8	6
1481FG10K		18	10	10	8	6
1481FG12K		18	12	12	8	6
1481FG16K		18	16	16	10	8
1481FK6K		24	6	6	5	4
1481FK8K		24	8	8	8	4
1481FK10K	1481FK10KSS	24	10	10	8	4
1481FK12K	1481FK12KSS	24	12	12	10	6
1481FK16K		24	16	16	12	8

# General Accessories

## General Accessories

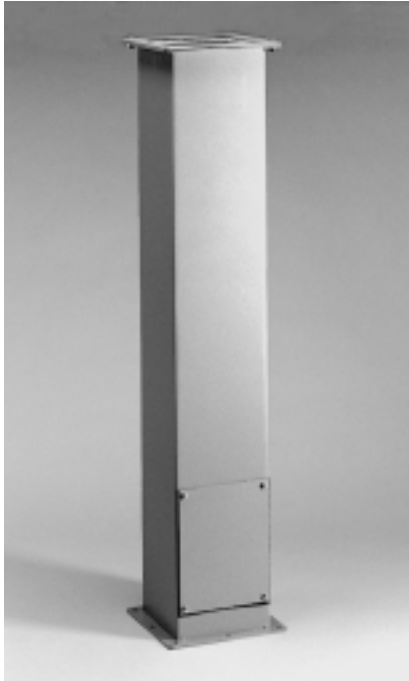

**Pedestal Column**

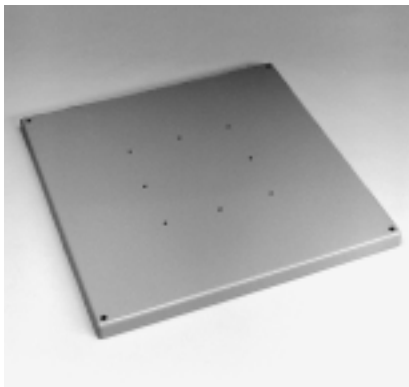

**Pedestal Base**

### Pedestal

- Used for floor mounting for many types of enclosures, consolets or pushbutton boxes
- Provides wiring feature through the column.
- Meets NEMA Type 12 and 13 requirements.
- Finished in gray.

### Pedestal Column

- Columns are formed from 14 gauge steel with 10 gauge flanges.
- Column access opening with gasketed cover.
- Columns include flange gaskets and a box connector.

### Pedestal Base

- Bases are formed from 10 gauge steel with additional reinforcing.
- Bases include levelling screws.

Part No.	Description	C	D	F	M	N	P
1495C35	Straight Column	-	3.75	2.75	7.25	6	-
1495D35	Straight Column	-	5.75	4.75	7.25	6	-
1495XK	Pedestal Base	18	-	-	-	-	0.5
1495XN	Pedestal Base	24	-	-	-	-	0.5

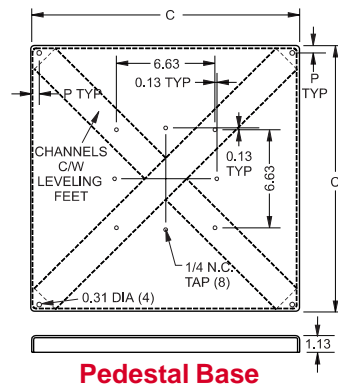

**Pedestal Base**

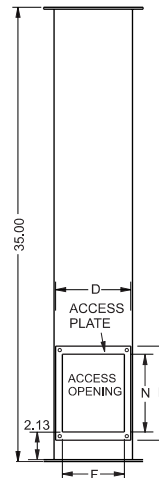

**Pedestal Column**

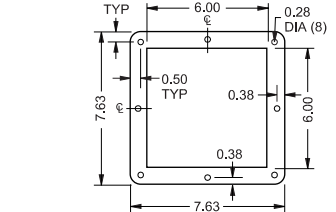
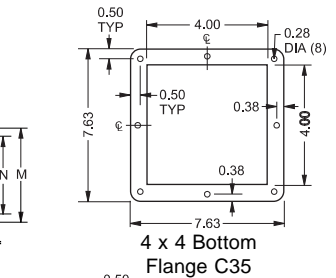
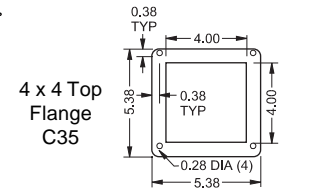

**6 x 6 Top and Bottom Flange D35**

# General Accessories

## General Accessories



### Touch-Up Paint (Spray Can)

- For use in matching standard Hammond colors.
- Provided in 12 oz. spray cans.

### Touch Up Paint Kit

- Kit is comprised of two 1/2 pint tins which must be mixed together in a 1:1 ratio as required.
- Matches standard Hammond NEMA 4/4X ASA 61 gray.
- Maintains NEMA, UL and CSA ratings.
- Total volume is 1 pint.

### Touch Up Paint - Spray Can

Part No.	Color
1413BKLGS	Black - Low Gloss
1413BKS	Black
1413CGRALS	Beige RAL7032
1413GFS	Gulf Blue
1413LRS	ASA 61 Gray
1413NS	White

### Touch Up Paint - Kit

Part No.	Color
1413HSEGYK	NEMA 4/4X ASA/61 Gray



### Louvered Ventilating Plate

- Provides ventilation in enclosures where required.
- Easily installed in the field by cutting a square hole of the proper size and bolting the ventilator in place.
- Finished in gray.
- Hole diameter is 0.22".



Part No.	Plate Size		No. of Louvers	No. of Rows	Louvers Length	Opening Area (in <sup>2</sup> )
	Height	Width				
1481L44	5.62	5.5	4	1	4	3.0
1481L66	7.87	7.5	14	2	2	2.8
1481L88	10.56	10.5	18	2	4	14.0

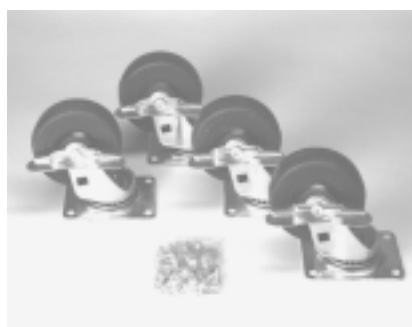

### Casters

- Packaged in sets of four.
- 800 lb. load capacity per set.
- 4" swivel casters with brakes.
- Features zinc plated ball bearing pivot, composite wheels.

Part No.	1425D
----------	-------



### 1425 Series Casters

- Packaged in sets of four.
- Feature ball bearing, swivel and hard composition wheels.
- Available for 3 weight capacities.

Part No.	Mfg. Specified Capacity (Set of 4)	Wheel Diameter Inches	Height Added To Cabinet Inches
1425B	360	3.0	0.75
1425BM	700	3.0	0.75
1425BH	1050	3.0	0.75

## General Accessories

### General Accessories



#### Literature Pocket Kit

- For use as additional or replacement literature pockets.
- Kit includes pocket, high strength two-sided adhesive tape and surface preparation swab.
- Plastic pocket is black.
- Packaged individually.

Part No.	Height	Width	Depth
<b>PKT66</b>	6	6	0.75
<b>PKT99</b>	6	9	0.75
<b>PKT1212</b>	12	12	2.50

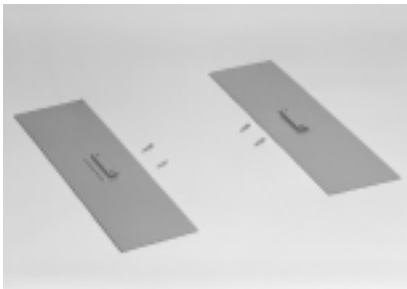

#### Enclosure Stabilizers

- Prevents floor mounted enclosures from falling over while being worked on before they are bolted to the floor.
- Install by slipping under enclosure mounting foot and tightening two thumb screws.
- Finished in gray.

Part No.	Overall Dimensions
<b>1481ES</b> (1 pair)	8x30



#### Panel Lifting Handles

- Used for lifting, transporting and installing panel assemblies in enclosures that are positioned horizontally.

Part No.	1481H

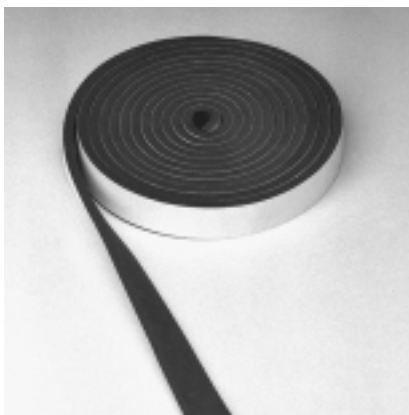

#### Neoprene Gasket Kit - NEMA 12 Enclosures

- Self-adhesive cellular neoprene gasket for NEMA 12 enclosures.
- Supplied in 10 foot rolls, 0.19" x 0.75".

#### Urethane Gasket Kit - NEMA 4, 4X Enclosures

- Self adhesive microcell urethane gasket for NEMA 4, 4X enclosures.
- Supplied in 10 foot rolls, 0.25" x 0.75".

Part No.	Material	For NEMA Type
<b>1481DJ10</b>	Neoprene	12
<b>1481DJN410</b>	Urethane	4, 4X